

TRIO COLLECTION



TECHNICAL DATA SHEET



Transforming barriers into opportunities.

The Trio Bench is a versatile and modular urban furniture product that can be customized to fit different needs. It has a unique design that allows it to be configured in various forms and functions, making it a great addition to any public space.

One of the key features of the Trio Bench is its ability to integrate planters. Depending on your preference, the bench can be ordered with no planters, one planter, or even two planters integrated inside of it. This is a great feature for those who want to add some greenery to their urban space.

The bench is made from high-quality materials that are weather-resistant and durable, making it suitable for outdoor use.

Overall, the Trio Bench is a versatile and functional piece of urban furniture that can be customized to fit different needs. Its unique design and integration of planters make it a great addition to any public space.

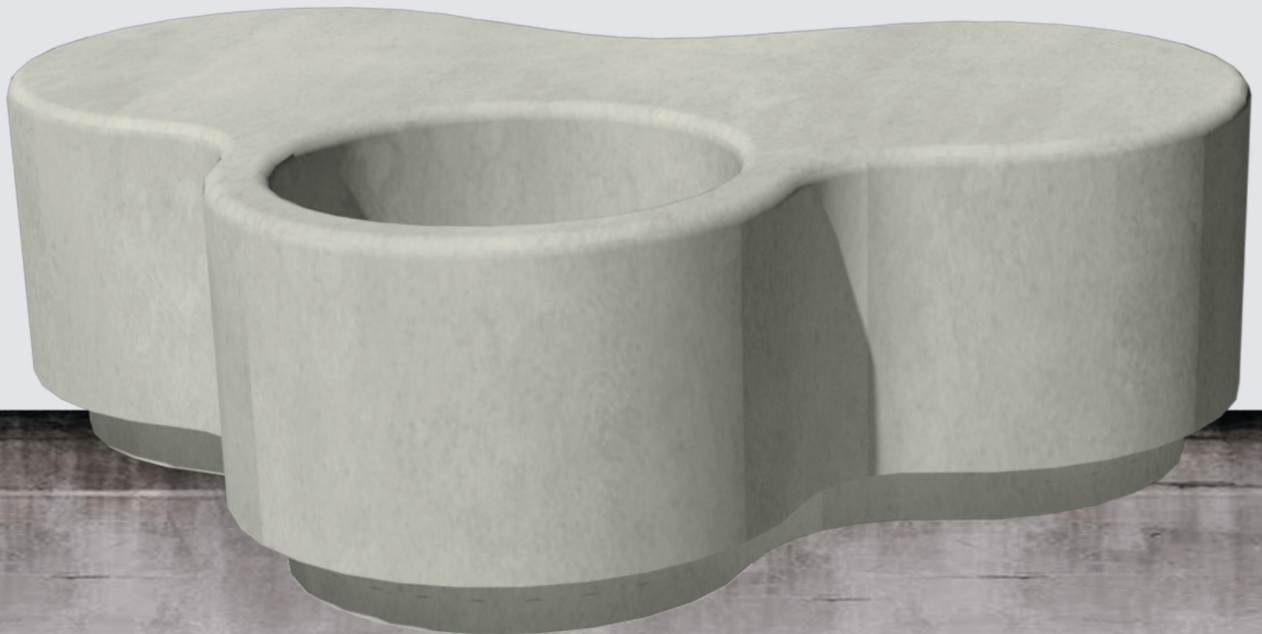
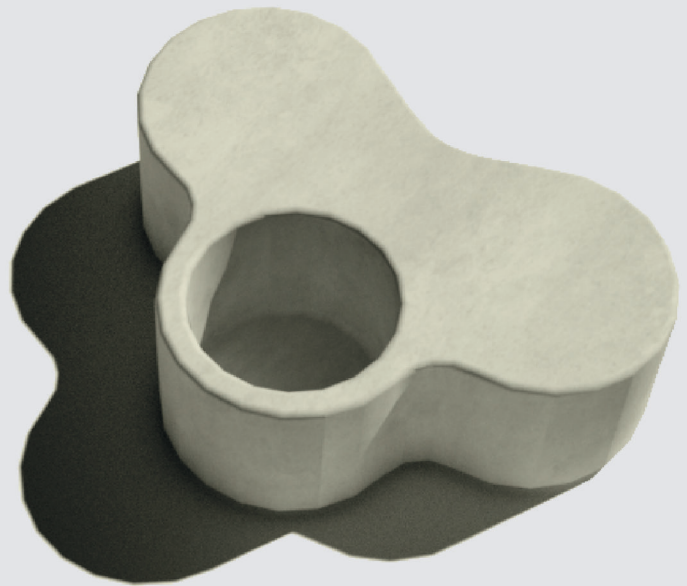





Trio bench and planter

Counter Anti-Terrorist Vehicle Barrier with Planter Module Inserted In The Design.

The trio bench is a modular product that can have alternatively different forms and different functions, with no planters, one planter or even two planters integrated inside of it.

 210 X 145 X 60 CM

 URBAN FURNITURE

Category: Vehicle Defence
 Sub Category: Below ground
 Material: Concrete
 Max Width: 2100mm
 Max Depth: 1450mm
 Above Ground: 500mm
 Below Ground: 100mm
 Overall Height: 600mm
 Weight With Planter: 2200kg
 Weight Without Planter: 2500kg

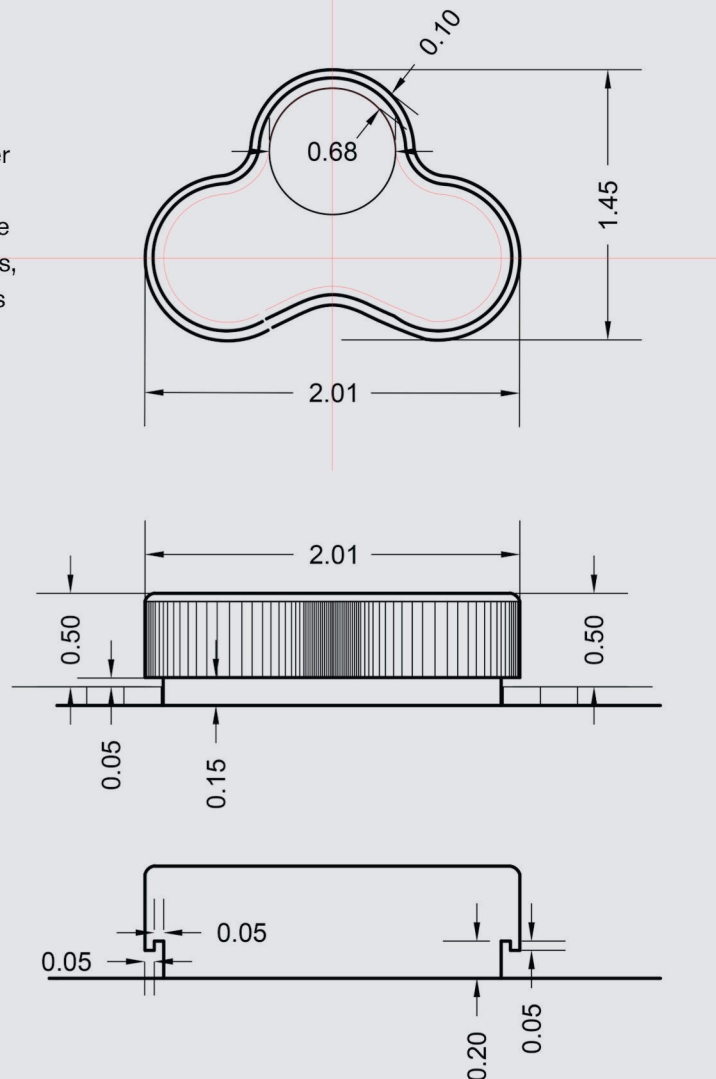



Trio single planter

Rounded planter with a designed lighting detail for a floating effect.

 60 X 60 X 45 CM

 URBAN FURNITURE

Category: Vehicle Defense

Sub Category: Accessory

Material: Concrete

Radius: 310mm

Height: 450mm

Weight: 200kg

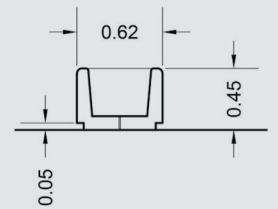
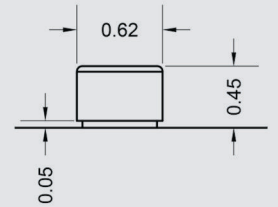
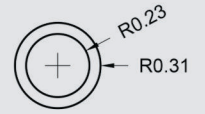

Trio single bench

Rounded bench with a designed lighting detail for a floating effect.

 60 X 60 X 45 CM

 URBAN FURNITURE

Category: Vehicle Defense

Sub Category: Accessory

Material: Concrete

Radius: 310mm

Height: 450mm

Weight: 300kg

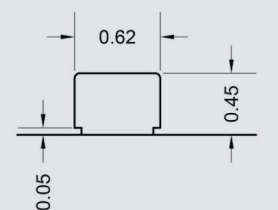
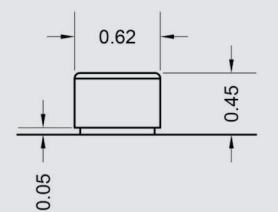

GET IN TOUCH

Contern
Lëtzebuenger Beton

📍 Contern, Luxembourg

☎ +352 35 88 11 - 1

✉ info@contern.com

🌐 contern.com

